

# PERGO®

## WOOD PARQUET

FLOORS  
FOR  
REAL LIFE

Sandhamn - Chevron  
Saltholm - Herringbone

# Patterns - a look that lasts

A patterned floor brings a new dimension to the natural beauty of a wood floor. If you are looking to add a distinct elegance to your interior, the Herringbone or Chevron patterns will bring personality and style to complement any room.

## FR | Motifs

### - une sensation qui demeure

Les motifs apportent une dimension inédite à la beauté naturelle d'un sol en bois. Si vous cherchez à ajouter une touche d'élégance unique à votre intérieur, les motifs à bâtons rompus ou à chevrons personnaliseront et styliseront n'importe quelle pièce.

## NL | Patterns -

### tijdloze grandeur

Een patroonvloer geeft een extra dimensie aan de natuurlijke schoonheid van een houten vloer. Visgraad- en chevronpatronen brengen verfijnde elegantie, karakter en stijl in elke ruimte.

## ES | Patrones:

### un aspecto duradero

Un suelo con patrón añade una nueva dimensión a la belleza natural de un suelo de madera. Si busca añadir distinción a un espacio de interior, los patrones de espiga o chevrón son perfectos para completar cualquier estancia con personalidad y estilo.

## CZ | Vzory

### – vzhled, který vydrží

Vzor dodává přírodní kráse dřevěné podlahy nový rozměr. Pokud chcete svému interiéru dodat jedinečný punc elegance, můžete zvolit chevronový vzor nebo vzor rybí kost, které do každé místnosti přinesou osobitost a styl.

## IT | Motivi

### - una bellezza che dura nel tempo

Un pavimento con motivi regala una nuova dimensione alla bellezza naturale del pavimento in parquet. Se ciò che desideri è aggiungere un tocco di eleganza ai tuoi interni, i motivi Herringbone o Chevron doneranno personalità e stile a completamento di ogni stanza.

## PL | Wzory

### — wygląd, który trwa

Wzorzysta podłoga wnosi nowy wymiar do naturalnego piękna drewnianej podłogi. Jeśli chcesz zapewnić wyjątkową elegancję w swoich wnętrzach, wzory herringbone lub chevron wniosą do każdego pomieszczenia osobowość i styl.

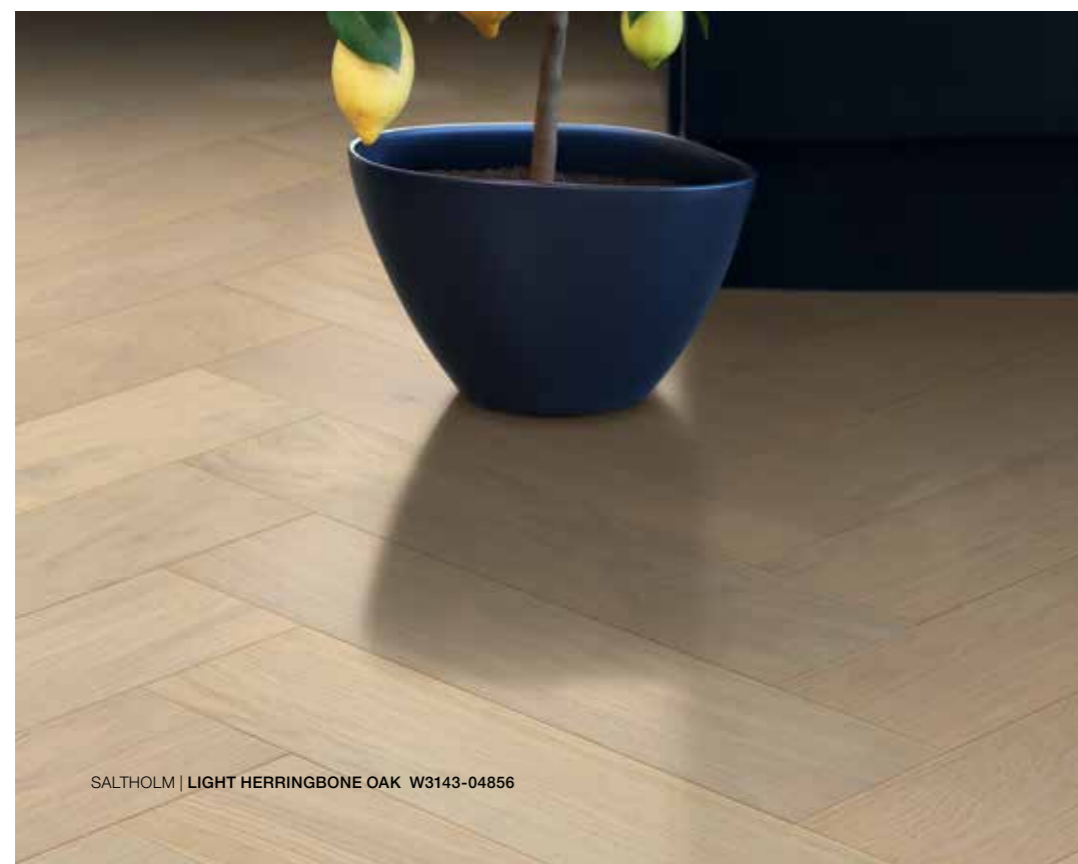



SALTHOLM

# Herringbone

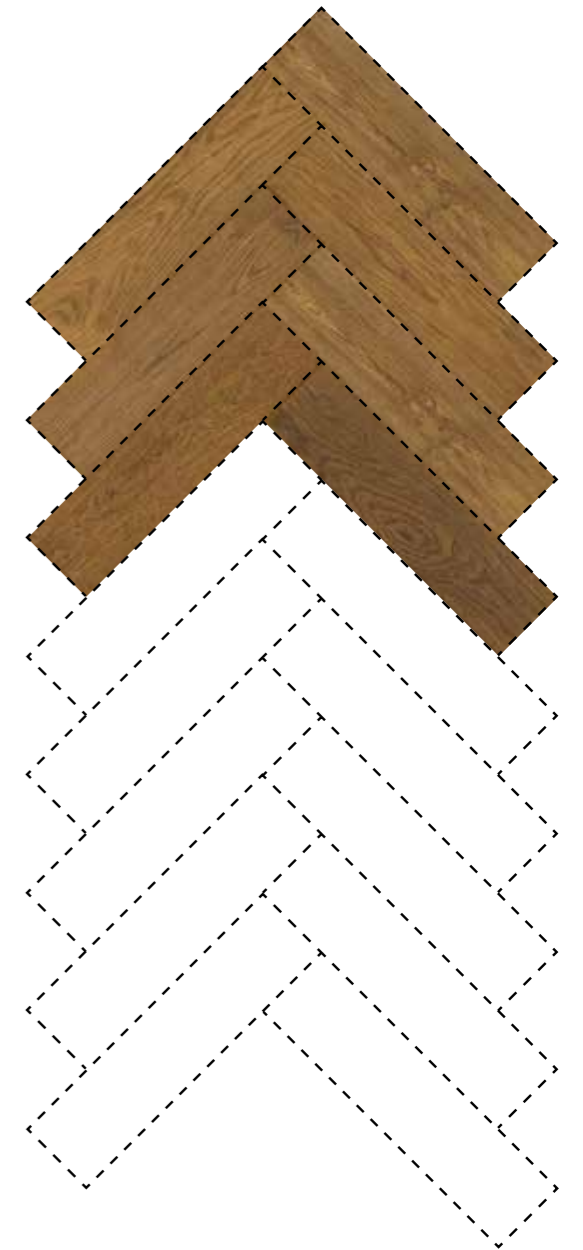

SANDHAMN

# Chevron



with  
StayClean!

EASY TO MAINTAIN



## Makes lacquered wood floors stay young

Untreated wood floors can be penetrated by dirt and water, causing permanent discolouring. Pergo one-strip lacquered wood floors, however, have StayClean protection that covers the entire facing of each plank. This makes our lacquered wood floors extra resistant to liquids and spills and prevents dirt from getting into the joints and wood texture.

### FR | permet aux parquets vernis de garder l'aspect du neuf !

En pénétrant dans les parquets non traités, l'eau et la saleté provoquent une décoloration permanente. Mais les parquets vernis Pergo une frise bénéficient de la protection StayClean qui recouvre l'intégralité du revêtement de chaque lame. Elle permet à nos parquets vernis d'être extrêmement résistants aux liquides et aux taches et empêche la saleté de pénétrer dans les joints et la structure du bois.

### ES | hace que los suelos de madera lacados conserven su belleza.

En los suelos de madera sin tratar la suciedad y el agua pueden penetrar y causar una decoloración permanente. Los suelos de madera lacados Pergo de un listón, sin embargo, cuentan con protección StayClean que recubre todo el revestimiento de cada tablón. Esto hace que nuestros suelos de madera lacados sean extremadamente resistentes a los líquidos y derrames, y evita que la suciedad penetre en las juntas y en la textura de la madera.

### CZ | lakované dřevěné podlahy zůstávají mladé!

Do nedopracovaných dřevěných podlah mohou proniknout nečistoty a voda a způsobit tak trvalé zbarvení. Nicméně, lakované podlahy Pergo z jednoho pruhu mají ochranu StayClean, která kryje celý povrch každé lamely. Díky tomu jsou naše lakované dřevěné podlahy velmi odolné vůči tekutinám a špíně a zabraňují vnikání nečistot do spojů a struktury dřeva.

### NL | zorgt ervoor dat gelakte houten vloeren er als nieuw blijven uitzien!

In onbehandelde houten vloeren kunnen vuil en water binnendringen, wat leidt tot permanente verkleuring. Enkelstrooks gelakte houten Pergo-vloeren hebben echter StayClean-bescherming die het volledige oppervlak van elke plank bedekt. Hierdoor zijn onze gelakte houten vloeren extra bestand tegen vloeistoffen en morsen en komt er geen vuil in de verbindingen en de houtstructuur.

### IT | permette ai pavimenti in legno verniciato di restare giovani!

Sporcizia e acqua potrebbero penetrare nei pavimenti in legno non trattati, provocando una decolorazione permanente. I pavimenti in legno verniciato Pergo One-Strip, tuttavia, dispongono della protezione StayClean che copre l'intera superficie di ogni tavola. Ciò rende i nostri pavimenti in legno verniciato extra resistenti a liquidi e fuoriuscite e impedisce allo sporco di penetrare negli incastri e nella texture del legno.

### PL | sprawia, że lakierowane podłogi drewniane wyglądają jak nowe!

W przypadku podłóg z nieobrobionego drewna istnieje ryzyko wnikania brudu i wody, co może prowadzić do powstawania trwałych przebarwień. Jednolamelowe lakierowane podłogi drewniane Pergo są pokryte warstwą ochronną StayClean, która obejmuje całą okładzinę każdej z desek. Dzięki temu są one wyjątkowo odporne na zanieczyszczenia i zaplamienia, a także na wnikanie brudu w łączenia i teksturę drewna.

without  
StayClean...

HIGH STABILITY



#### 1 Protective finish, 7 layers of high quality laquer or 2 layers of UV oil

FR | Finition protectrice, 7 couches de vernis ou 2 couches d'huile de qualité supérieure  
ES | 7 capas de barniz a base de agua con protección UV o 2 capas de aceite de alta calidad  
CZ | Ochranná povrchová úprava, 7 vrstev vysoce kvalitních laků nebo olejů  
NL | 7 lagen UV-uitgeharde lak op waterbasis of 2 lagen kwaliteitsolie  
IT | Finitura protettiva, 7 strati di vernice o 2 di olio ad alta resistenza  
PL | Warstwa zabezpieczająca, 7 warstw wysokiej jakości lakieru lub 2 warstwy oleju

#### 2 Face layer (2.5 or 3 mm), can be sanded 2 – 3 times

FR | Parement (2,5 ou 3 mm), peut être poncé 2 à 3 fois ES | Capa visible (2,5 o 3 mm), se puede pulir 2 o 3 veces  
CZ | Čelní vrstva (2,5 nebo 3 mm), lze brousit 2 – 3 krát NL | De oppervlaktelaag (2,5 of 3 mm) kan 2 – 3 keer worden geschuurd  
IT | Strato nobile (2,5 o 3 mm), può essere lamato 2 – 3 volte PL | Warstwa wierzchnia (2,5 lub 3 mm) możliwa 2 – 3 krotna renowacja.

#### 3 Advanced core

FR | Âme de qualité supérieure ES | Núcleo avanzado CZ | Zdokonalené jádro  
NL | Geavanceerde kern IT | Strato centrale di supporto PL | Zaawansowany rdzeń

#### 4 Balanced backing

FR | Contre-parement ES | Refuerzo equilibrado CZ | Vyvážený podklad  
NL | Tegenlaag IT | Strato di bilanciamento PL | Stabilizująca warstwa spodnia

**Pergo wood floors consist of 3 layers of wood with the grain running in different directions to reduce the natural swelling and shrinking caused by fluctuations in temperature and humidity.**

FR | Les parquets Pergo sont constitués de 3 couches de bois dont le grain est orienté dans différentes directions pour réduire la dilatation et la rétraction naturelles causées par les fluctuations de température et d'humidité.

ES | Los suelos de madera Pergo constan de 3 capas de madera con vetas distribuidas en diferentes direcciones para reducir la expansión y contracción naturales causadas por las fluctuaciones de temperatura y humedad.

CZ | Dřevěné podlahy Pergo obsahují 3 vrstvy s vlákny v různých směrech, aby se snížilo přirozené bobtnání a smršťování způsobené odchylkami teploty a vlhkosti.

NL | Houten Pergo-vloeren bestaan uit 3 lagen hout, waarbij de nerf in verschillende richtingen loopt om de natuurlijke uitzetting en krimpings als gevolg van schommelingen in temperatuur en vochtigheid te verminderen.

IT | La struttura multistrato Pergo garantisce, grazie al diverso orientamento delle venature, la massima stabilità dimensionale al variare di temperatura e umidità, anche nella posa flottante.

PL | Podłogi Pergo zbudowane z trzech warstw drewna, posiadają stabilną krzyżową konstrukcję ograniczającą pracę deski przy zmianach temperatury oraz wilgotności.

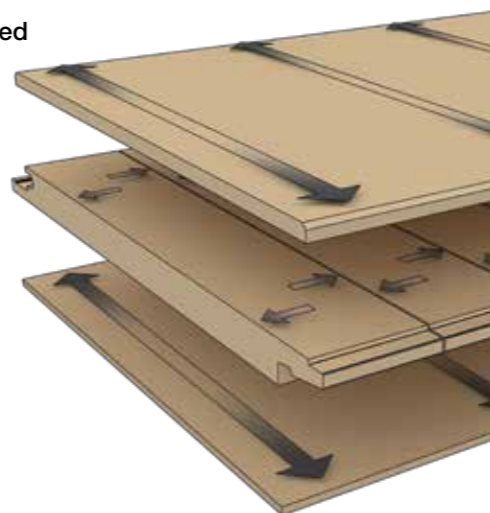

EASY TO INSTALL

## PerfectFold™ click installation

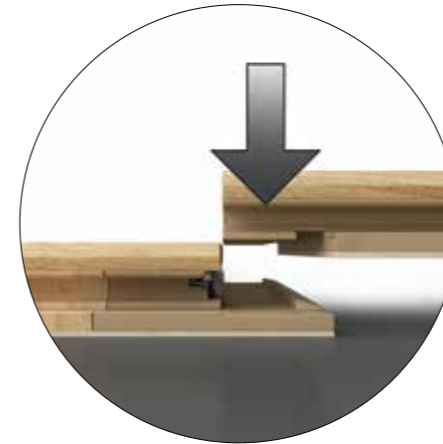

### Drop down

The ideal method for quickly installing a large area. Angle the plank at the long side joint, slide it until it meets the end of the previously installed plank, and press down.

FR | Chute de lame  
ES | Deslizamiento y clic  
CZ | Spuštění  
NL | Drop down  
IT | Incastro dall'alto  
PL | Dosuwanie

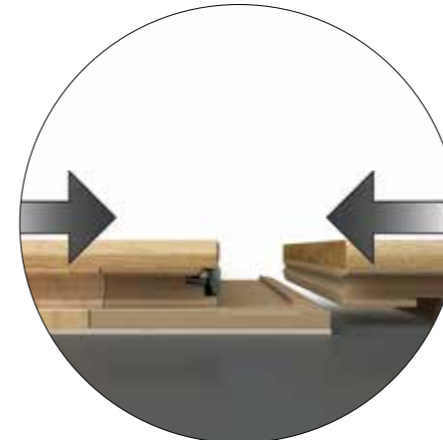

### Insert horizontally

Unlike many other brands, Pergo wood floors can also be inserted horizontally. A very handy option for places where it is difficult or impossible to tilt the planks (when installing the last row of planks, or under door frames and radiators).

FR | L'insertion à l'horizontale  
ES | Instalación horizontal  
CZ | Horizontální vložení  
NL | Horizontaal invoegen  
IT | Incastro orizzontale  
PL | Wkładanie poziome

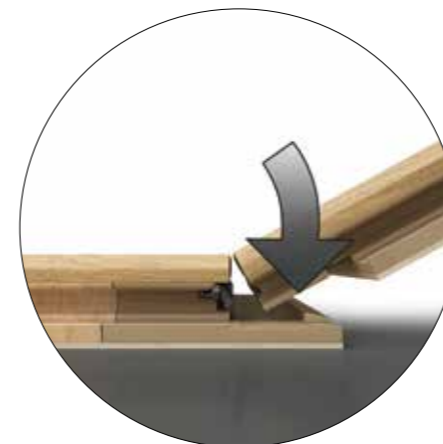

### Angle

If you prefer, Pergo offers a third option for installing your new wood floor. Simply angle and click the planks together at the short end.

FR | Inclinaison  
ES | Inclinación  
CZ | Pod úhlem  
NL | In een hoek  
IT | Incastro ad angolo  
PL | Pod kątem

# Grading

FR choix | ES clasificación | CZ třídění | NL houtsortering | IT selezione | PL klasyfikacja



## Selected

Wood with knots up to 20 mm; variation in colour and structure

FR | Bois avec nœuds jusqu'à 20 mm, variations de couleurs et de structures

ES | Madera con nudos de hasta 20 mm; variación en color y estructura

CZ | Dřevo se suký do 20 mm; odchylky v barvě a struktuře

NL | Hout met knoesten tot 20 mm; variatie in kleur en structuur

IT | Nodi fino a 20 mm; tonalità e superfici variegata

PL | Drewno z sękami do 20 mm, zróżnicowanie koloru i struktury



## Lively

Wood with big knots up to 80 mm and cracks; lively variation in colour and structure and a rather rustic appearance

FR | Bois avec de gros nœuds jusqu'à 80 mm et des fissures, variations dynamiques de couleurs et de structures et aspect assez rustique. ES | Madera con grandes nudos de hasta 80 mm y grietas; fuertes variaciones en color y estructura, y aspecto rústico. CZ | Dřevo s velkými suký do 80 mm a prasklinami; výrazné odchylky v barvě a struktuře a spíše rustikální vzhled. NL | Hout met grote knoesten tot 80 mm en barsten; levendige variatie in kleur en structuur en een vrij rustieke uitstraling. IT | Nodi fino a 80 mm e stucature; stonalizzazioni pronunciate, autentico fascino rustico. PL | Drewno z dużymi sękami do 80 mm i spękaniem, wyraźne zróżnicowanie koloru i struktury oraz aczej rustykalny wygląd

# Structure

FR structure | ES estructura | CZ struktura | NL structuur | IT superficie | PL struktura



## Brushed

Brushing the surface of a wood plank accentuates the natural grain structure, and enhances the authentic look and feel of the wood

FR | Sur une lame de parquet, l'effet brossé permet d'accentuer la structure naturelle du grain de bois et de rehausser l'aspect et la sensation authentiques du bois. ES | Al cepillar la superficie de un tablón de madera se realza la estructura de la veta natural y se acentúa el aspecto y la sensación de autenticidad de la madera. CZ | Broušení povrchu dřevěného prkna zvýrazňuje přirozenou strukturu vláken a podtrhuje autentický vzhled dřeva. NL | Door een houten plank te borstelen worden de natuurlijke nerfstructuur en de authentieke look en feel van het hout benadrukt. IT | La superficie spazzolata evidenzia la grana e venatura del legno. PL | Szczotkowanie powierzchni drewnianej deski podkreśla naturalną strukturę słoików oraz wzmacnia wygląd i charakter prawdziwego drewna

# Finish

FR finition | ES acabado | CZ povrchová úprava | NL afwerking | IT rifinitura | PL wykończenie



## Extra matt lacquer

FR | vernice extra matt

ES | lacado mate adicional

CZ | extra matný lak

NL | extra matte lak

IT | vernice extra opaca

PL | lakier extra matowy

# Sustainability for the long run

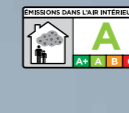

Caring for the environment has always played a central role in everything we do. As a testament to our efforts, Pergo was the first flooring manufacturer ever to achieve the official Nordic Ecolabel, the Nordic Swan. Through our parent company UNILIN, Pergo flooring is also the first to receive the European Ecolabel for laminate flooring, along with other certificates and quality requirements.

**FR | Une durabilité à long terme.** Prendre soin de l'environnement a toujours joué un rôle central dans toutes nos actions. Témoignant de nos efforts, Pergo a été le premier fabricant de revêtements de sol à avoir obtenu l'Ecolabel Nordique officiel, le Nordic Swan. Par l'intermédiaire de notre société mère UNILIN, les revêtements de sol Pergo sont également les premiers à recevoir l'Ecolabel européen pour les revêtements de sols stratifiés, ainsi que d'autres certificats et exigences de qualité.

**ES | Resistencia a largo plazo.** El respeto por el medio ambiente siempre ha ocupado un lugar clave en todo lo que hacemos. Como prueba de nuestros esfuerzos al respecto, Pergo ha sido el primer fabricante de suelos en obtener la ecoetiqueta nórdica Nordic Swan. A través de nuestra empresa matriz UNILIN, los suelos de Pergo han sido los primeros en conseguir la etiqueta ecológica de la UE para sus suelos laminados, así como otros certificados y requisitos de calidad.

**CZ | Dlouhodobá odolnost.** Starost o životní prostředí vždy hrála hlavní roli ve všem, čím se zabýváme. Toto úsilí potvrzuje skutečnost, že Pergo byl vůbec prvním výrobcem podlah, který obdržel oficiální skandinávské osvědčení o ekologické značce: Nordic Swan. Díky naší partnerské společnosti UNILIN získaly podlahy Pergo jako první také evropskou ekoznačku společně s dalšími certifikáty a požadavky na kvalitu.

**NL | Duurzaam op lange termijn.** Zorg voor het milieu heeft altijd een centrale rol gespeeld bij alles wat we doen. Als bewijs van onze toewijding heeft Pergo als eerste vloerenfabrikant het officiële Nordic Ecolabel, de Nordic Swan, verworven. Via onze moedermaatschappij UNILIN hebben Pergo-vloeren ook als eerste het Europese Ecolabel voor laminaatvloeren ontvangen, samen met andere certificaten en kwaliteitseisen.

**IT | Durevolezza sul lungo periodo.** La cura per l'ambiente ha sempre avuto un ruolo centrale in tutto ciò che facciamo. A dimostrazione del nostro impegno, Pergo è stato il primo produttore di pavimenti ad aver ottenuto l'Ecolabel Scandinavo ufficiale, Nordic Swan, il Cigno Verde. Tramite la società madre UNILIN, il pavimento Pergo è anche stato il primo a ricevere l'Ecolabel europeo per i pavimenti in laminato, congiuntamente ad altri certificati e requisiti di qualità.

**PL | Trwałość w długiej perspektywie.** Dbałość o środowisko zawsze odgrywała istotną rolę w naszej działalności. Potwierdza to fakt, że firma Pergo była pierwszym producentem podłóg, który uzyskał oznaczenie Nordic Swan. Będąc częścią firmy UNILIN, marka Pergo również jako pierwsza otrzymała znak EU Ecolabel dla podłóg laminowanych, a także wiele innych atestów i certyfikatów.



# Sandhamn

1050 x 310 x 14 mm | 3 mm surface

General data			
Panel	1050 x 310 mm		
Total thickness	14 mm		
Numbers of panels per pack	4		
m <sup>2</sup> per pack	1,302 m <sup>2</sup>		
Kg per pack	16,40 kg		
Panel build up			
Toplayer	PEFC controlled sources	3 mm	
Core board	HDF Mastercore		
Backing layer	PEFC controlled sources	Spruce or Pine	2 mm
Tongue and groove	Length	Uniclic	
	Width	Uniclic	
Warranty			
Domestic use	Conditions in each pack	33 years	
Uniclic connection	Lifetime		
Commercial	On request		
Surface layer			
Wood species	Oak		
Origine	Europe		
Finishing	UV cured oil	2 layers	
	UV cured lacquer	Anti-scratch top coat	5 - 7 layers
Natural Variance	Due to nature, visual surface can deviate from samples		
Grading	cf catalogue/website		
Surface treatments	cf catalogue/website		
Installation			
Underfloor heating	Suitable with glued installation	cf special installation instructions	
Glued to subfloor	Pergo MS polymere resin	cf installation instructions	
Classification properties			
Wear resistance	SIS 923509	Falling sand	800 - 1000
	DIN 68861	S 33	100 - 1050
Scratch resistance	Anti-scratch top coat		
Stain resistance	EN 13442	All except blue ink	class 5
		Blue ink	class 3
CE	EN 14342: 2013	Notified body	0766 EPH Dresden DOP PW 0504
Castor chairs	ISO 4918	Tested with underlay	25.000
Slip resistance	CEN/TS 15676	Dry pendulum test	Depending on structure and surface treatment USRV 37-57
Emission of formaldehyde	EN 717-1	E1	
PCP	CEN/TR 14823:2004		
Heat resistance	EN 12664	0,105 m <sup>2</sup> .K/W	
Reaction to fire	EN 13501-1	Cl-s1	
Ecological certificates			
AFFSET	A	France	
PEFC	PEFC/07-32-37		
M1	OK	Finland	
EPD	On request		
Nordic Swan Ecolabel	3029 0001		



**GRADINGS:**  
Lively    
Brushed Extra matt lacquer

For technical reasons the colours printed here may differ from actual floor colours. We recommend visiting a dealer to view a sample prior to purchase.

# Saltholm

580 x 145 x 14 mm | 3 mm surface | 4-way bevel



## General data

Panel	580 x 145 mm
Total thickness	14 mm
Numbers of panels per pack	4
m <sup>2</sup> per pack	1,009 m <sup>2</sup>
Kg per pack	9,88 kg

## Panel build up

Toplayer	PEFC controlled sources	EN 13489	±3 mm
Core board	PEFC controlled sources		Spruce
Backing layer	PEFC controlled sources	Wood Veneer	2 mm
Tongue and groove	Length		Uniclic
	Width		Uniclic

## Warranty

Domestic use	Conditions in each pack	33 years
Uniclic connection		Lifetime
Commercial		On request
Moisture Protection	Provides a warranty on build-up of residue dirt along the edges due to maintenance over the years	10 years
Stay Clean Technology	Provides a warranty on pollution of surface structure and a warranty on build-up residue dirt along the edges due to maintenance over the years	10 years

## Surface layer

Wood species	Oak		
Origine	Europe		
Finishing	UV cured lacquer	Anti-scratch top coat	5 - 7 layers
Natural Variance	Due to nature, visual surface can deviate from samples		
Grading	cf catalogue/website		

## Installation

Underfloor heating	Suitable	cf special installation instructions
Glued to subfloor	Pergo MS polymere resin	cf installation instructions

## Classification properties

Wear resistance	SIS 923509	Falling sand	800 - 1000
	DIN 68861	S 33	100 - 1050
Scratch resistance	Anti-scratch top coat		
Stain resistance	EN 13442		class 5
		Floors with Stay Clean Technology	class 3
CE	EN 14342: 2013	Notified body	0766 EPH Dresden
Castor chairs	ISO 4918	Tested with underlay	25.000
Slip resistance	CEN/TS 15676	Dry pendulum test	Depending on structure and surface treatment
			USRV 37-57
Emission of formaldehyde	EN 717-1		≤E1
PCP	CEN/TR 14823:2004		≤5 ppm
Heat resistance	EN 12664		0,14 m <sup>2</sup> .K/W
Reaction to fire	EN 13501-1		Dfl-s1

## Ecological certificates

AFFSET	A	France
PEFC	PEFC/07-32-37	
M1	OK	Finland
EPD	On request	
Nordic Swan Ecolabel	3029 0001	





GRADINGS:     
Selected    Brushed    Extra matt lacquer    Matt lacquer

For technical reasons the colours printed here may differ from actual floor colours. We recommend visiting a dealer to view a sample prior to purchase.



# underlays for wood subfloors

FR sous-couches pour supports en bois | ES materiales de base para subsuelos de madera | CZ podložky pro dřevěné podlahové podklady | NL ondervloeren voor houten ondergronden | IT materassini per sottofondi in legno | PL podkłady na podłoża drewniane

	GOOD	BETTER	BEST
	bien   bueno   dobrý goed   buono   dobry	mieux   mejor   lepší beter   migliore   lepszy	meilleur   máximo   nejlepší best   ottimo   najlepszy
	<b>Underlay Foam</b>	<b>Smart Underlay</b>	<b>Silent Walk</b>
Durability	●●○○○○	●●●●○○	●●●●●●
Walking sound reduction	●●○○○○	●●●○○○	●●●●●○
Floor heating**	●●●○○○	●○○○○○	●●●●●●
Vapour barrier	NO	NO	YES*
Thickness	2 mm	3 mm	2 mm
			
	<b>Underlay Foam, 15 m<sup>2</sup></b> PGUDLFOAM15B For rooms with light traffic.	<b>Smart Underlay, 15 m<sup>2</sup></b> PGUDLSMART15 For rooms with frequent traffic.	<b>Silent Walk, 7 m<sup>2</sup></b> PGUDLSW7 Very durable and strong underlay for rooms with more frequent traffic.

# underlays for concrete subfloors

FR sous-couches pour supports en béton | ES materiales de base para subsuelos de cemento | CZ podložky pro betonové podlahové podklady | NL ondervloeren voor betonnen ondergronden | IT materassini per sottofondi in cemento | PL podkłady na podłoża betonowe

	GOOD	BETTER	BEST
	bien   bueno   dobrý goed   buono   dobry	mieux   mejor   lepší beter   migliore   lepszy	meilleur   máximo   nejlepší best   ottimo   najlepszy
	<b>Underlay Foam+</b>	<b>Smart Underlay+</b>	<b>Silent Walk</b>
Durability	●●●○○○	●●●●○○	●●●●●●
Walking sound reduction	●●●○○○	●●●○○○	●●●●●○
Floor heating	●●●○○○	●○○○○○	●●●●●●
Vapour barrier	YES	YES	YES*
Thickness	2 mm	3 mm	2 mm
			
	<b>Underlay Foam+</b> PGUDLFOAMPLUS15 A good basis for rooms with less traffic. Integrated vapour barrier with an overlap and tape strip included. 15 m <sup>2</sup> / roll.	<b>Smart Underlay+</b> PGUDLSMARTPLUS15 Good in rooms with more frequent traffic. Integrated vapour barrier an overlap and tape strip included. 15 m <sup>2</sup> / pack.	<b>Silent Walk</b> PGUDLSW7 A very durable and strong underlay for rooms with more frequent traffic. 7 m <sup>2</sup> / roll.

# Wallbases





FR plinthes | ES rodapiés | CZ soklové lišty | NL plinten | IT battiscopa | PL listwy przyściennie

		
<b>Wallbase, straight</b> PGWPPSKR(-), 2400 x 16 x 80 mm (see matching matrix for correct art no) Surface: wear and scratch-resistant veneer. Core: MDF. Colour matched.	<b>Wallbase, white &amp; paintable</b> PGWPPSKRWHITE, 2400 x 16 x 80 mm, white PGWPPSKRPAINT, 2400 x 16 x 80 mm, paintable Surface: foil. Core: MDF. Colour: white (NCS 0502 Y), paintable.	<b>Beading</b> PGSCOTWHITE, 2400 x 17 x 17 mm, white PGSCOTPAINT, 2400 x 17 x 17 mm, paintable  Surface: foil. Core: MDF. Colour: white, paintable.

# 5-in-1 profile

FR 5-en-1 profilé | ES 5 en 1 | CZ 5 v 1 lišta  
NL 5-in-1 profiel | IT profilo 5-in-1 | PL profil 5 w 1

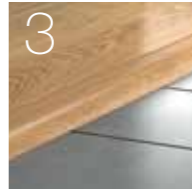
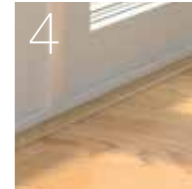

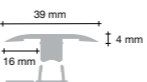
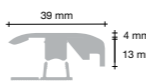
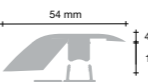
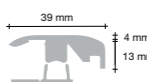
					
<b>T-moulding</b> 	<b>Carpet transition</b> 	<b>Hard surface reducer</b> 	<b>End moulding</b> 	<b>Stair nose moulding, flush</b>	<b>Stair nose moulding</b>
			<b>PGWINCP(-)</b> 2150 x 17 x 54 mm (see matching matrix for correct art no)	<b>The Incizo® subprofile is required for stair application and has to be ordered separately.</b>  NEWINCPBASE3ME215, for 14 mm floors NEWINCPBASE2ME215, for 12.5 mm floors	

# Maintenance

FR entretien | ES mantenimiento | CZ údržba | NL onderhoud | IT manutenzione | PL konserwacja

		
<b>Cleaning kit</b> PGCLEANINGKIT High-quality mop set with extra-long ergonomic handle and a mop cloth holder with a practical Velcro fastener for attaching the mop cloth.	<b>All round Floor Cleaner</b> PGCLEANALL1000, 1000 ml Specially developed for laminate, wood and vinyl flooring. For removing dirt, grease spots, heel marks, as well as for daily cleaning.	<b>Repair wax</b> PGREPAIR Contains 1 melting knife, 1 comb, 7 wax blocks. For more information on how to mix colours please visit pergo.com

# Technical guide: accessories

FR guide technique : accessoires | ES guía técnica: accesorios | CZ technický přehled  
 NL technische gegevens: accessoires | IT guida tecnica: accessori | PL informacje techniczne: akcesoria

Underlays		Piece			Pack		Pallet		Ord. Unit	
		length mm	width mm	height mm	qty /pc**	pc /pack	qty /pack**	pc /pallet		qty /pallet**
PGUDLFOAM15B	Underlay Foam (box)	15800	950	1.8	15 m <sup>2</sup>	12	180 m <sup>2</sup>	24	360 m <sup>2</sup>	roll
PGUDLSMART15	Smart Underlay	15000	1000	3	15 m <sup>2</sup>	9	135 m <sup>2</sup>	18	270 m <sup>2</sup>	pc
PGUDLSMARTPLUS15	Smart Underlay+	15000	1000	3	15 m <sup>2</sup>	9	135 m <sup>2</sup>	18	270 m <sup>2</sup>	pc
PGUDLSW7	Silent Walk	7000	1000	2	7 m <sup>2</sup>	20	140 m <sup>2</sup>	40	280 m <sup>2</sup>	roll
PGUDLFOAMPLUS15	Underlay Foam+	15789	950	2	15 m <sup>2</sup>	10	150 m <sup>2</sup>	20	300 m <sup>2</sup>	roll
NEUDLSB10	(Neutral) Sofboard	790	590	4	0.46 m <sup>2</sup>	22	10.25 m <sup>2</sup>	24	246 m <sup>2</sup>	pack

Wallbases		length mm	width mm	height mm	qty /pc**	pc /pack	qty /pack**	pc /pallet	qty /pallet**	Ord. Unit
PGWPPSKR(-)	Wallbase, straight, color m.	2400	16	80	2.4 r.m.	6	14.4 r.m.	360	864	pc
PGWPPSKRWHITE	Wallbase, straight, white	2400	16	80	2.4 r.m.	6	14.4 r.m.	360	864	pc
PGWPPSKRPAINT	Wallbase, straight, paintable	2400	16	80	2.4 r.m.	6	14.4 r.m.	360	864	pc
PGSCOTWHITE	Beading, white	2400	17	17	2.4 r.m.	6	14.4 r.m.	918	2203.2	pc
PGSCOTPAINT	Beading, paintable	2400	17	17	2.4 r.m.	6	14.4 r.m.	918	2203.2	pc

Profiles		length mm	width mm	height mm	qty /pc**	pc /pack	qty /pack**	pc /pallet	qty /pallet**	Ord. Unit
PGWINCP(-)	5-in-1	2150	17	54	2.15 r.m.	1	2.15 r.m.	266	571.9 r.m.	pc
NEWINCPBASE2ME215	Stair base for 12.5 mm floors	2150	73.5	17	2.15 r.m.	1	2.15 r.m.	234	503.1 r.m.	pc
NEWINCPBASE3ME215	Stair base for 14 mm floors	2150	73.5	17	2.15 r.m.	1	2.15 r.m.	234	503.1 r.m.	pc
PGSTPSILVME270N	Stair profile	2700	23	17	2.15 r.m.	4	10.8 r.m.	120	324 r.m.	pc
PGWSTP(-)	Sstair profile for open stairs	2150	54	17	2.15 r.m.	3	6.45 r.m.	240	1548 r.m.	pc

Maintenance		length mm	width mm	height mm	qty /pc**	pc /pack	qty /pack**	pc /pallet	qty /pallet**	Ord. Unit
PGCLEANINGKIT	Cleaning kit	760	200	50		10		150		pc
PGCLEANALL1000	All round floor cleaner	265	80	80	1000 ml	10	10 l	500		pc
PGREPAIR	Repair wax	290	125	28		12		648		pc

## Matching matrix

FR tableau des correspondances | ES tabla de correspondencias | CZ vzorník  
 NL matchingtabel | IT matrice di abbinamento | PL tablica kompletowania



Sandhamn		5-in-1 17 x 54 PGWINCP(-)	Wallbase straight 16 x 80 PGWPPSKR(-)	Sealant 310 ml PGKIT(-)
W2434-04371	Natural Manor Oak	01334	01334	5
W2434-04374	Smoked Manor Oak	03096	03096	4

Saltholm		5-in-1 17 x 54 PGWINCP(-)	Wallbase straight 16 x 80 PGWPPSKR(-)	Sealant 310 ml PGKIT(-)
W3143-04856	Light Herringbone Oak	04856	04856	3
W3143-05115	Natural Herringbone Oak	05115	05115	4
W3143-04979	Brown Herringbone Oak	03096	03096	4



**Our floors look even better in real life**

Visit our website for reference cases and free samples

[pergo.com](http://pergo.com)

**PERGO®**

Pergo is a quality product produced by **UNILIN** bv, division flooring, Ooigemstraat 3, 8710 Wielsbeke, Belgium. Member of **MOHAWK**

